

PDF technical sheet EX21031G2L3

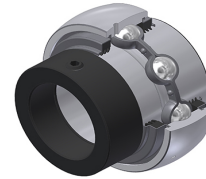

Insert bearings

spherical outer diameter, fixing by eccentric locking collar, triple lip seal

Product definition	
B	1.9370 "
B1	2.4685 "
B2	0.7205 "
C	0.9055 "
C1	0.2559 "
d	1.9375 "
d1	2.6457 "
D	3.5433 "
G	5/1624UNF
m	0.2559 "
r	1.1
S	0.9685 "
SW	0.1563 "

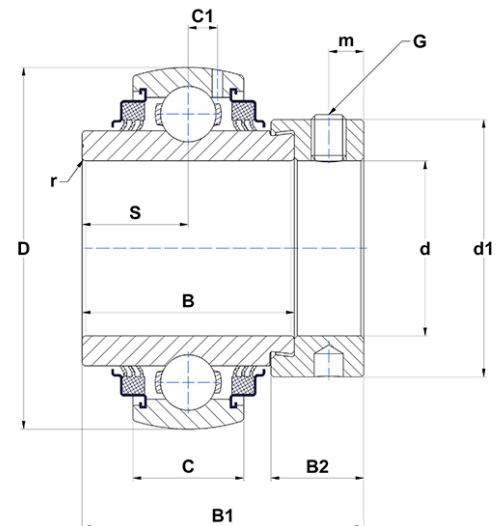

m.ncatalog.fo.featuresotherperformance	
C	35.10 kN
C0	23.20 kN
T min.	-4 °C
T max.	212 °C

Other features	
Weight	3.67 oz
Recommended tightening torque for set screw	8 Nm