

PDF technical sheet EX20721G2L3

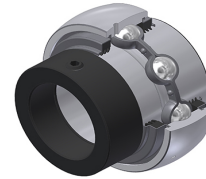

Insert bearings

spherical outer diameter, fixing by eccentric locking collar, triple lip seal

Product definition	
B	1.4803 "
B1	2.0118 "
B2	0.6890 "
C	0.7874 "
C1	0.2283 "
d	1.3125 "
d1	2.0118 "
D	2.8346 "
G	5/1624UNF
m	0.2559 "
r	1.1
S	0.7402 "
SW	0.1563 "

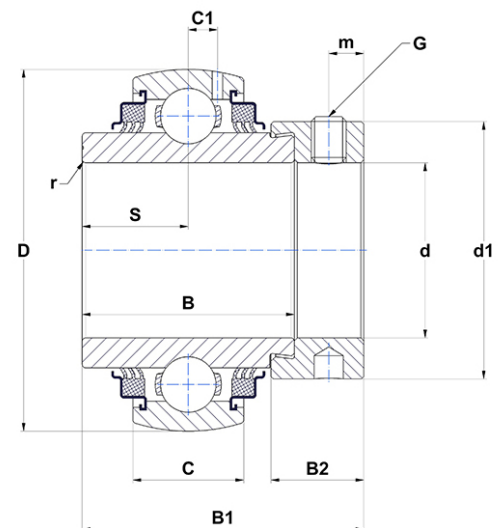

m.ncatalog.fo.featuresotherperformance	
C	25.70 kN
C0	15.20 kN
T min.	-4 °C
T max.	212 °C

Other features	
Weight	2.26 oz
Recommended tightening torque for set screw	8 Nm