

PDF technical sheet EX20514G2L3

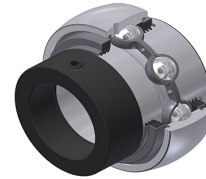

Insert bearings

spherical outer diameter, fixing by eccentric locking collar, triple lip seal

Product definition	
B	1.3701 "
B1	1.7441 "
B2	0.5315 "
C	0.6693 "
C1	0.1693 "
d	0.8750 "
d1	1.4724 "
D	2.0472 "
G	1/428UNF
m	0.1969 "
r	0.6
S	0.6850 "
SW	0.1250 "

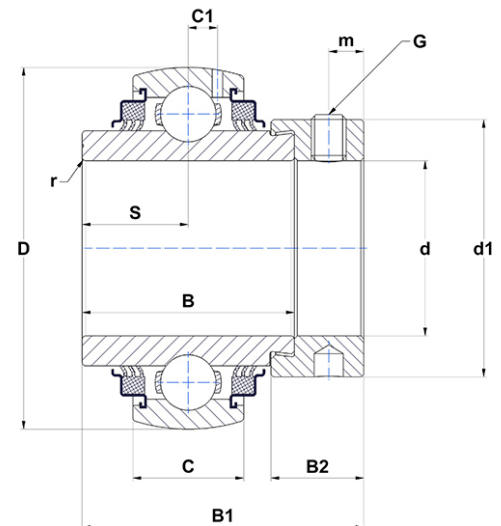

m.ncatalog.fo.featuresotherperformance	
C	14 kN
C0	7.88 kN
T min.	-4 °C
T max.	212 °C

Other features	
Weight	0.88 oz
Recommended tightening torque for set screw	3.70 Nm