

PDF technical sheet EX202G2L4

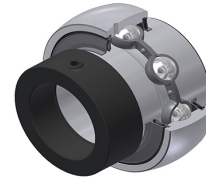

Insert bearings

zinc-coated insert, spherical outer diameter, fixing by eccentric locking collar, L4 - sealing system

Product definition	
B	1.3386 "
B1	1.7126 "
B2	0.5315 "
C	0.6299 "
C1	0.1732 "
d	0.5906 "
d1	1.2756 "
D	1.8504 "
G	M6x1
m	0.1969 "
r	0.6
S	0.6693 "
SW	0.1181 "

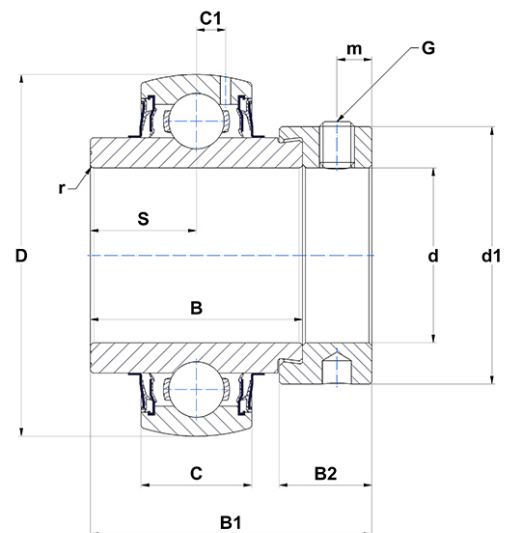

m.ncatalog.fo.featuresotherperformance	
C	12.80 kN
C0	6.65 kN
T min.	-4 °C
T max.	212 °C

Other features	
Weight	0.95 oz
Recommended tightening torque for set screw	5.50 Nm