

PDF technical sheet ESR202B

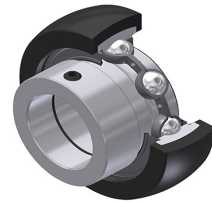

Insert bearings

spherical outer diameter with rubber damping ring, IR zinc-coated, fixing by eccentric locking collar, single lip seal

Product definition	
B	0.7480 "
B1	1.1260 "
B3	1.2165 "
C	0.4724 "
C2	0.6929 "
d	0.5906 "
d1	1.0709 "
d3	1.3189 "
D	1.5748 "
D3	1.8622 "
G	M6x1
m	0.1969 "
r	15
S	0.2559 "
SW	0.1181 "

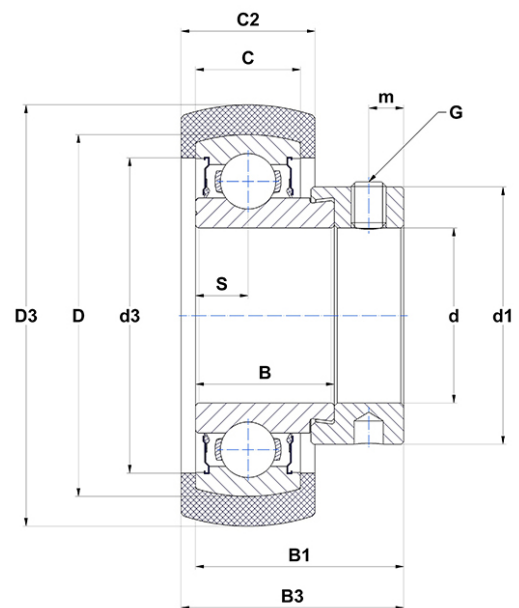

m.ncatalog.fo.featuresotherperformance	
C	9.55 kN
C0	4.78 kN
T min.	-4 °C
T max.	185 °C

Other features	
Weight	0.53 oz
Recommended tightening torque for set screw	5.50 Nm