

PDF technical sheet CUS20516

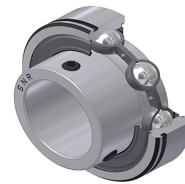

Insert bearings

cylindrical outer diameter, fixing by socket set screw, single lip seal

Product definition	
a	0.0937 "
b	0.0531 "
B	1.0630 "
C	0.5906 "
d	1.0000 "
D	2.0472 "
G	1/428UNF
m	0.1969 "
N1	1.9579 "
r	1
S	0.2953 "
SW	0.1250 "

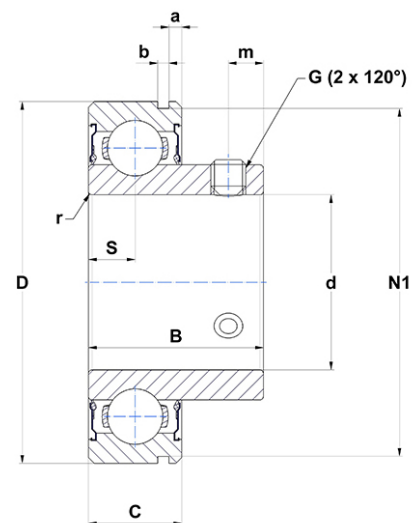

m.ncatalog.fo.featuresotherperformance	
C	14 kN
C0	7.88 kN
T min.	-4 °C
T max.	212 °C

Other features	
Weight	0.63 oz
Recommended tightening torque for set screw	3.70 Nm