

PDF technical sheet CUC206

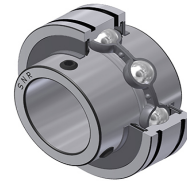

Insert bearings

cylindrical outer diameter, fixing by socket set screw, seal with slinger

Product definition	
a	0.1260 "
b	0.0748 "
B	1.5000 "
C	0.7480 "
C1	0.1654 "
d	1.1811 "
D	2.4409 "
G	M6x1
m	0.2165 "
N1	2.3469 "
r	0.6
S	0.6260 "
SW	0.1181 "

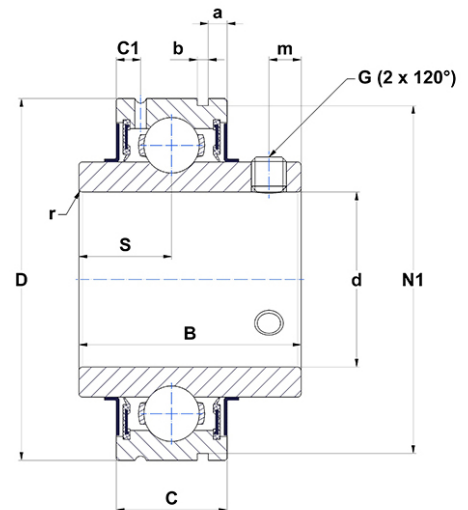

m.ncatalog.fo.featuresotherperformance	
C	19.50 kN
C0	11.20 kN
T min.	-4 °C
T max.	212 °C

Other features	
Weight	1.23 oz
Recommended tightening torque for set screw	5.50 Nm