

PDF technical sheet 22311EG15W33C4



Double row spherical roller bearings

Spherical roller bearing, polyamide cage, groove and lubrication holes on outer ring

Product definition	
d	2.1654 "
D	4.7244 "
B	1.6929 "
d2	2.7047 "
D1	4.0512 "
rs min	0.0787 "
Number of lubrication holes	3
b	0.3071 "
k	0.1378 "
e	0.36
Y1	1.87
Y2	2.79
Y0	1.83
Radial clearance class	C4
Mass	8.01 oz
Brand	SNR

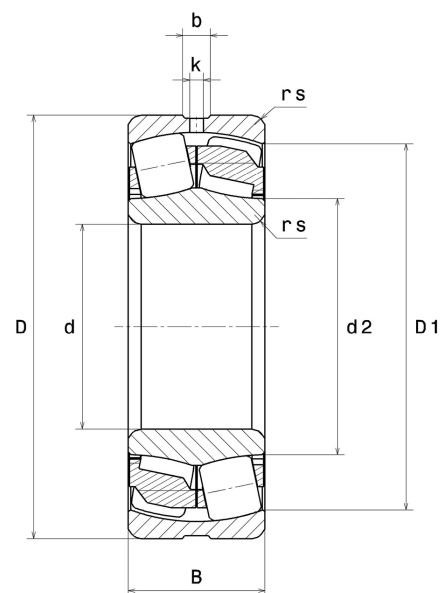

Product performance	
Dynamic load, C	296 kN
Static load, C0	274 kN
Fatigue limit load, Cu	25.40 kN
Nref	4,600 RPM
Nlim	5,600 RPM
Min operating temperature, Tmin	-4 °C
Max operating temperature, Tmax	248 °C
Characteristic cage frequency, FTF	0.40 Hz
Characteristic rolling element frequency, BSF	4.70 Hz
Characteristic outer ring frequency, BPF0	5.61 Hz
Characteristic inner ring frequency, BPF1	8.39 Hz

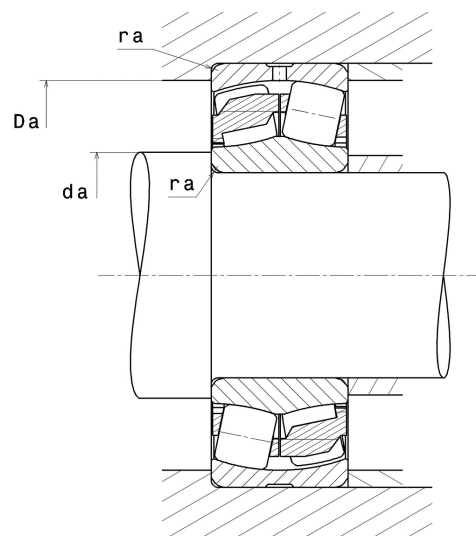

Abutment dimensions

da min	2.5984 "
Da max	4.2913 "
ra max	0.0787 "

Calculation factors

Equivalent dynamic radial load

$$P = X.F_r + Y.F_a$$

Fa / Fr ≤ e		Fa / Fr > e	
X	Y	X	Y
1	Y1	0.67	Y2

Equivalent static radial load

$$P_0 = X_0.F_r + Y_0.F_a$$

X ₀	Y ₀
1	Y0

The values for e, Y1, Y2 and Y0 are shown in the above table .