

PDF technical sheet 22230EMKW33C4



Double row spherical roller bearings

Spherical roller bearing, one-piece machined cage, groove and lubrication holes on outer ring, tapered bore 1:12

Product definition	
d	5.9055 "
D	10.6299 "
B	2.8740 "
D1	9.4921 "
rs min	0.1181 "
Number of lubrication holes	3
b	0.6024 "
k	0.2756 "
Associated sleeve reference	H3130
e	0.25
Y1	2.74
Y2	4.08
Y0	2.68
Radial clearance class	C4
Mass	62.76 oz
Brand	SNR

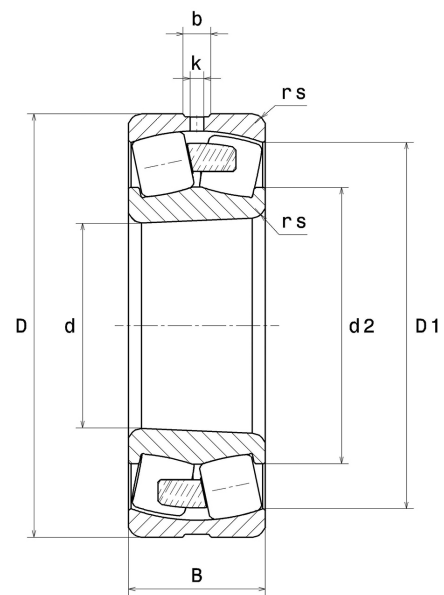

Product performance	
Dynamic load, C	1,080 kN
Static load, C0	1,220 kN
Fatigue limit load, Cu	106 kN
Nref	2,200 RPM
Nlim	3,000 RPM
Min operating temperature, Tmin	-40 °C
Max operating temperature, Tmax	392 °C
Characteristic cage frequency, FTF	0.42 Hz
Characteristic rolling element frequency, BSF	6.18 Hz
Characteristic outer ring frequency, BPF0	7.60 Hz
Characteristic inner ring frequency, BPF1	10.40 Hz

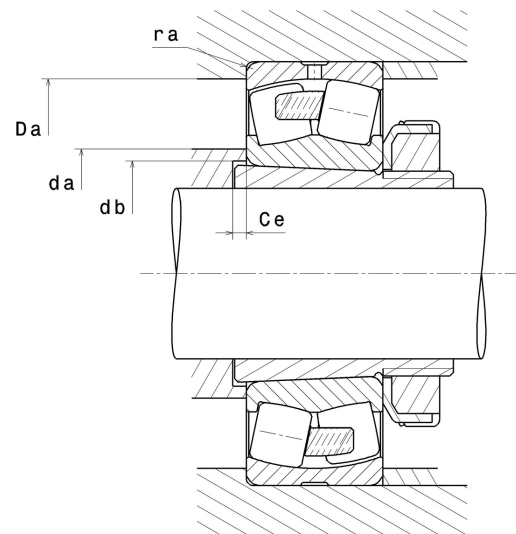

Abutment dimensions

da min	6.4567 "
Da max	10.0787 "
ra max	0.0984 "

Calculation factors

Equivalent dynamic radial load

$$P = X.F_r + Y.F_a$$

Fa / Fr ≤ e		Fa / Fr > e	
X	Y	X	Y
1	Y1	0.67	Y2

Equivalent static radial load

$$P_0 = X_0.F_r + Y_0.F_a$$

X ₀	Y ₀
1	Y0

The values for e, Y1, Y2 and Y0 are shown in the above table .