

PDF technical sheet 22220EAKW33C3



Double row spherical roller bearings

Spherical roller bearing, pressed steel cage, groove and lubrication holes on outer ring, tapered bore 1:12

Product definition	
d	3.9370 "
D	7.0866 "
B	1.8110 "
d2	4.6535 "
D1	6.3307 "
rs min	0.0827 "
Number of lubrication holes	3
b	0.4409 "
k	0.1969 "
Associated sleeve reference	H320
e	0.24
Y1	2.84
Y2	4.23
Y0	2.78
Radial clearance class	C3
Mass	16.65 oz
Brand	SNR

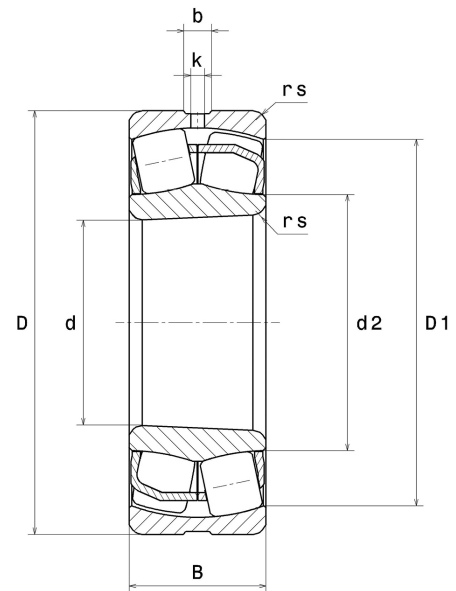

Product performance	
Dynamic load, C	472 kN
Static load, C0	495 kN
Fatigue limit load, Cu	52.60 kN
Nref	3,600 RPM
Nlim	4,600 RPM
Min operating temperature, Tmin	-40 °C
Max operating temperature, Tmax	392 °C
Characteristic cage frequency, FTF	0.42 Hz
Characteristic rolling element frequency, BSF	6.23 Hz
Characteristic outer ring frequency, BPF0	7.61 Hz
Characteristic inner ring frequency, BPF1	10.39 Hz

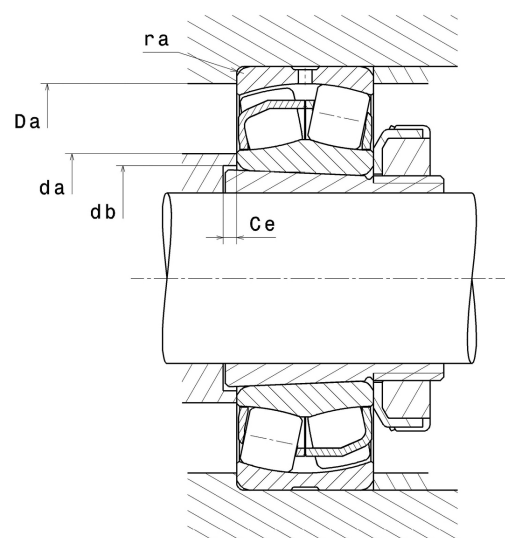

Abutment dimensions

da min	4.4094 "
Da max	6.6142 "
ra max	0.0787 "

Calculation factors

Equivalent dynamic radial load

$$P = X.F_r + Y.F_a$$

Fa / Fr ≤ e		Fa / Fr > e	
X	Y	X	Y
1	Y1	0.67	Y2

Equivalent static radial load

$$P_0 = X_0.F_r + Y_0.F_a$$

X ₀	Y ₀
1	Y0

The values for e, Y1, Y2 and Y0 are shown in the above table .