

Bearings	Adapter sleeve	Fixing rings (2x)	Fixing rings (1x)	feltstrip
1212 K C3	H212		FR110/8	FS 8 x 6,5 x 225
2212 K C3	H312		FR110/2	
22212 K	H312		FR110/2	

PDF technical sheet 722512 DB



Flanged housings 722500

flanged housing for bearings on adapter sleeve, made of ductile cast, for grease lubrication

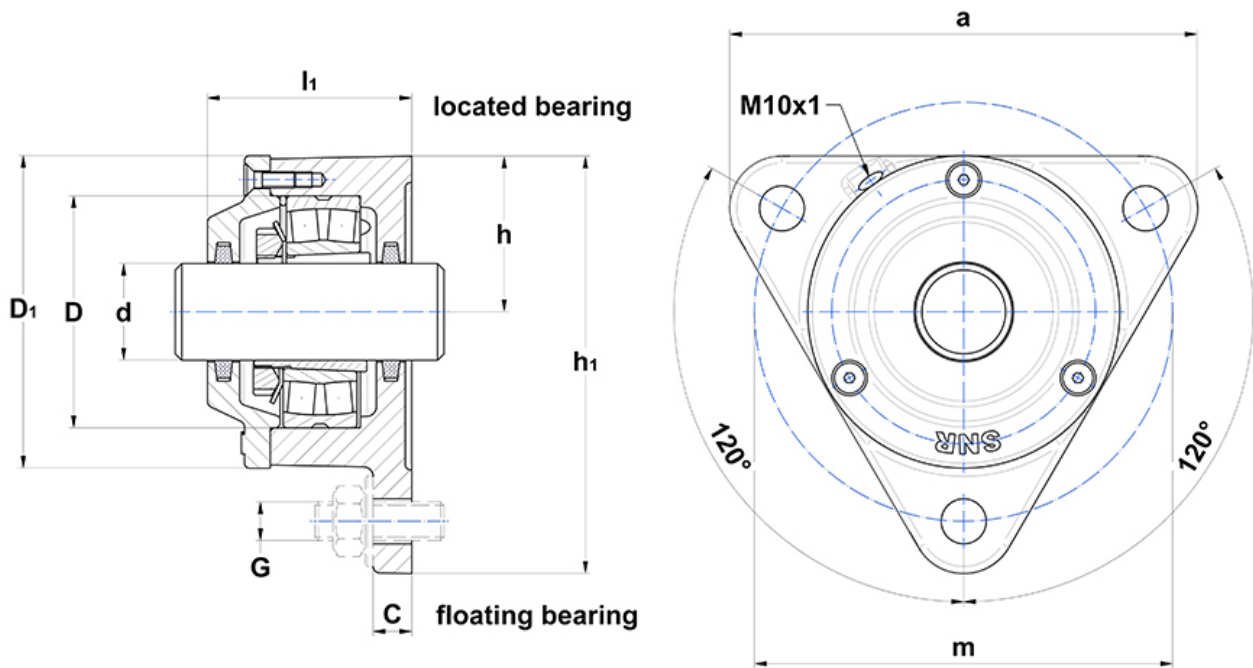

Product definition	
d	2.1654 "
a	8.2677 "
c	0.4724 "
h	2.8346 "
h1	7.4409 "
l1	3.2283 "
m	7.0866 "
N	0.5512 "
D	4.3307 "
housing weight	16.93 oz
Material of Housing	grey cast
Brand	SNR

Screws	
recommended torque	65 Nm
Cover bolts	M6x20
recommended torque	7 Nm